



Kids PROJECTS™

WIND CHIME CREATOR instruction sheet

STEP 1. First put down some old newspaper to prevent mess. Get a small container of water to wash your brush in. Wear a smock or old clothes to protect clothing.

STEP 2. Paint your terracotta pots. You may want to paint a simple background consisting of a few plain colours. Don't forget to paint your pots upside down, as that is how they will hang. Wash paint brush immediately between colours. Allow to dry.

Tip. Paint with lighter colours first.

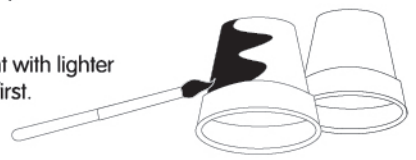

STEP 3. Choose a design to apply from your stencil sheet. Steadily hold it over the desired area and slowly apply the paint. Apply brush strokes from outside the shape to the centre so the paint does not go under the stencil sheet.



STEP 4. Create Butterflies.

Glue 2 pop sticks across each other to form a cross.



STEP 5.

Glue the pop stick cross to the top of a wooden peg.

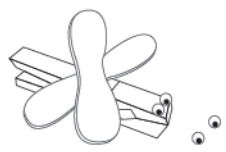

STEP 6. Add 2 googly eyes to the end of the peg.

STEP 7. Using your brush, paint your peg butterflies any way you like, or just follow the picture on the front of the box. Repeat for all butterflies.

STEP 8. Using the above ruler as a guide, cut 4 lengths of thread at 15cm.

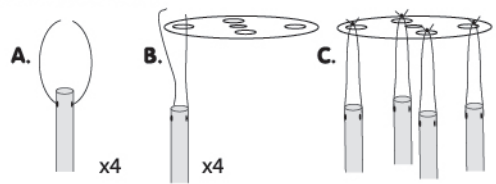

- A.** Take a chime and a 15cm thread, loop the thread through the 2 holes in the chime.
- B.** Loop the thread through the chime holder and tie a knot so it is secure.
- C.** Repeat for all 4 chimes.

STEP 9. Cut another length of thread, make this piece about 500mm.

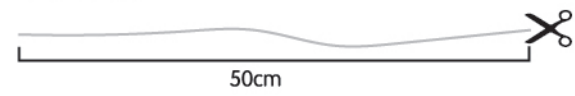

STEP 10. Tie this piece in the middle hole of your chime holder (with the chimes that were tied in step 8). Make the knot large so it doesn't fit through the hole of the chime holder. The chimes should hang as shown.

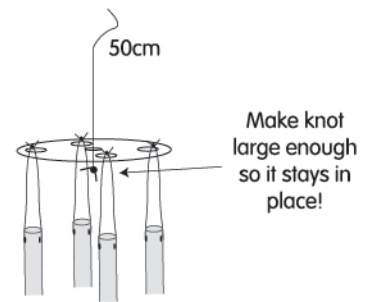

STEP 11.

A. Tie another knot about 9cm from the wind chime holder piece. Make the knot large enough so it doesn't fit through the hole of the chime holder. Slide another chime holder down the length until it is set in place.

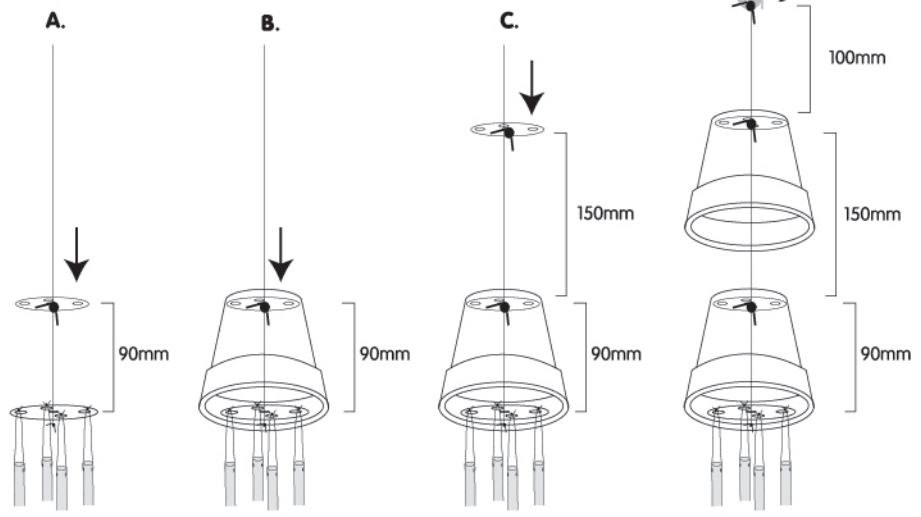

- B.** Slide one of the painted pots down the length until it stays in place.
- C.** Tie another knot 15cm above the pot and make the knot large enough so it doesn't fit through the hole of the chime holder. Slide another chime holder down the length until it's set in place.
- D.** Slide the other painted pot down the length so it hangs above the first pot. It should stay in place. Leave another 100mm of thread above the pot and then tie to the hang hook. Cut any leftover thread lengths.

STEP 12.

Take each of your butterflies and peg them to any spaces on the thread.

STEP 13.

Now you can hang your windchime anywhere you like! It is recommended to hang under shelter areas to avoid it deteriorating in weather.

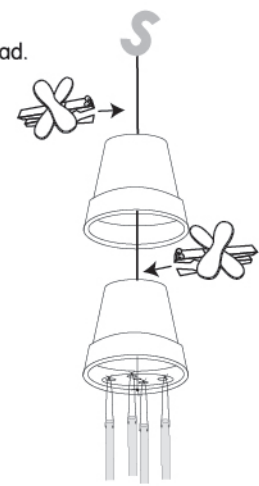

THINKING GREEN! TIPS FOR SUSTAINABILITY

- Sell or donate your toy rather than landfilling it if possible.
- Dispose of packaging responsibly*
- *Check with your local authority for further information on responsible recycling.

Adult supervision required.