



INSTRUCTION SHEET

LIGHTNING McQUEEN & MATER

PIXAR

- Following the steps, gently remove the wood shapes from the sheets. Use the top end of your brush to help press them out.
- Add a drop of glue where necessary to affix wood shapes together and firmly hold for approximately 30 seconds.



ADD A DROP OF GLUE TO AFFIX WOOD SHAPES TOGETHER AND FIRMLY HOLD FOR APPROXIMATELY 30 SECONDS.

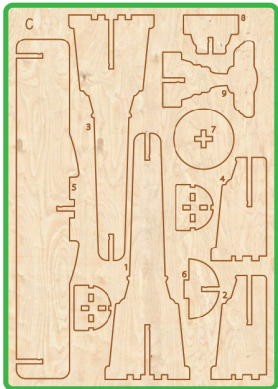
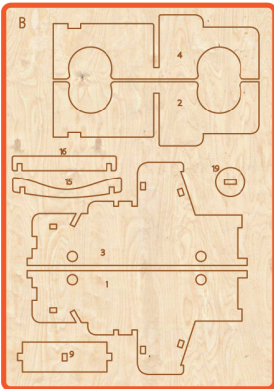
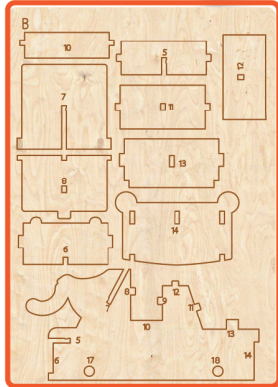
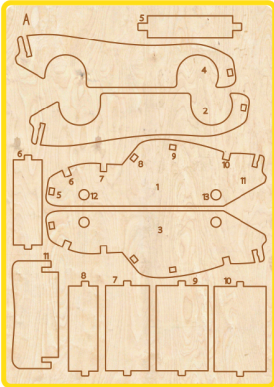

TIPS:

Do not force any wooden shapes into their corresponding holes if they do not appear to fit. Gently wiggle into place giving minimal force. Some pieces may require a light sand with the included sandpaper. Also, please note wood is a natural product and may expand in heat or extreme conditions. Avoid contact with water.

STEP 1

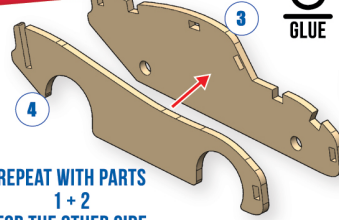

REPEAT WITH PARTS 1+2 FOR THE OTHER SIDE



RESULT

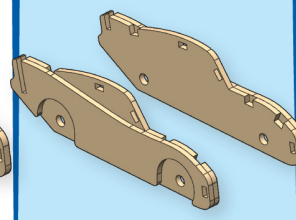

STEP 5

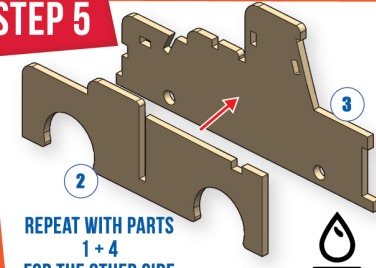

REPEAT WITH PARTS 1+4 FOR THE OTHER SIDE



RESULT

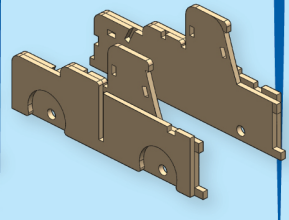

STEP 2

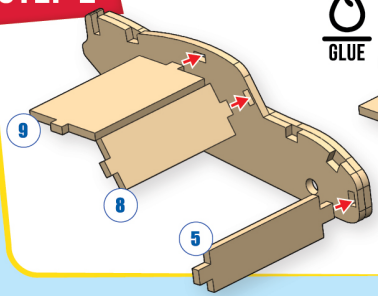

RESULT

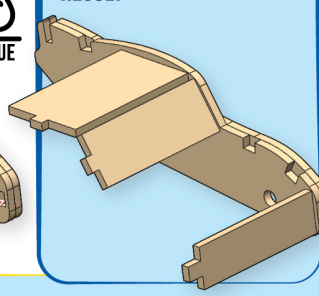

STEP 6

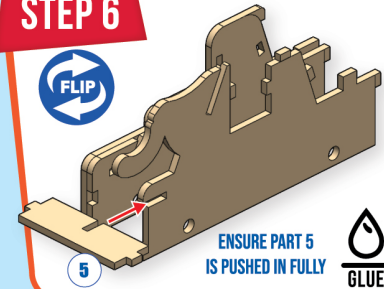

ENSURE PART 5 IS PUSHED IN FULLY



RESULT

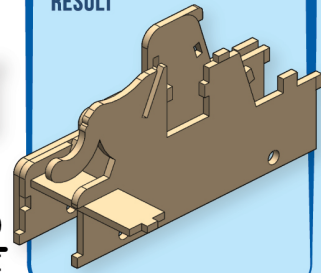

STEP 3

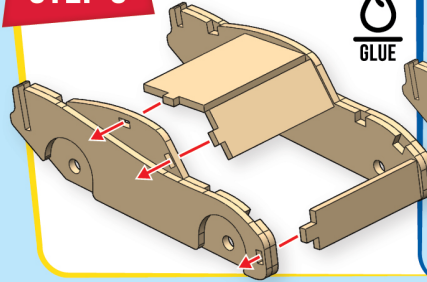

RESULT

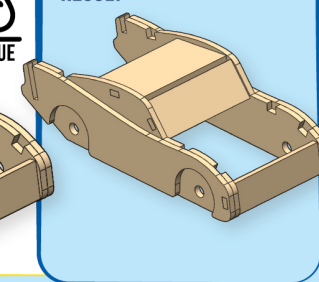

STEP 7

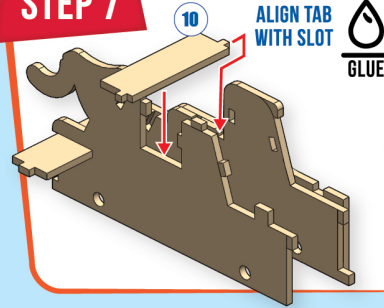

ALIGN TAB WITH SLOT



RESULT

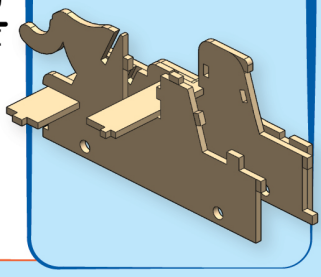

STEP 4

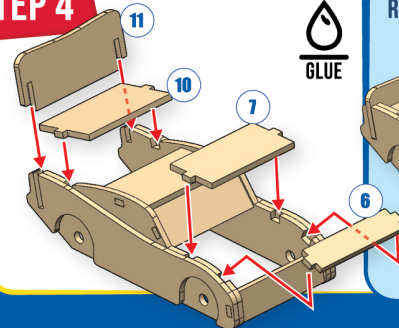

RESULT

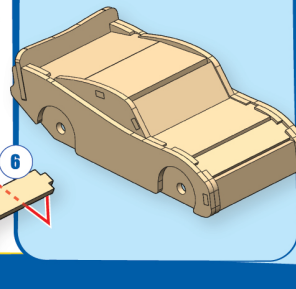

STEP 8

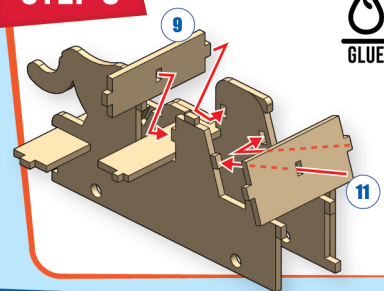

RESULT

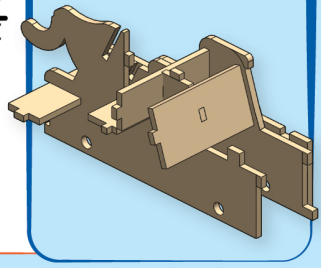

STEP 9

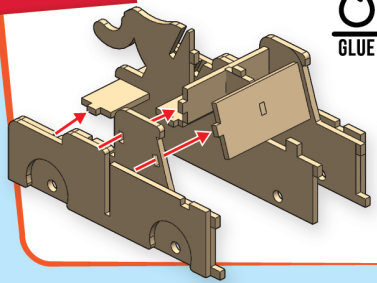

RESULT

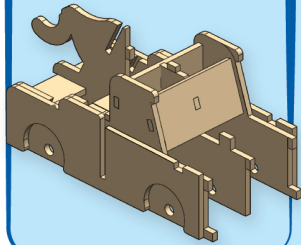

STEP 13



3
6

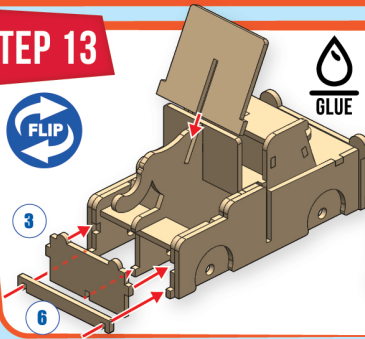

RESULT

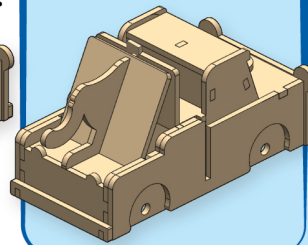

STEP 10

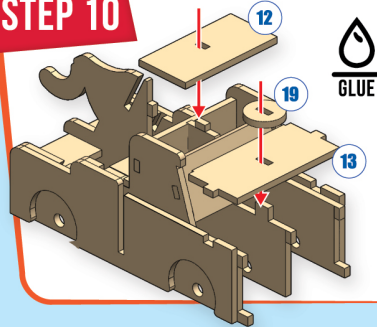

RESULT

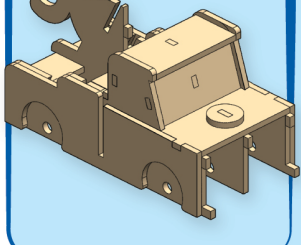

STEP 14

ONLY USE GLUE ON WHEEL WHEN JOINING AXLES

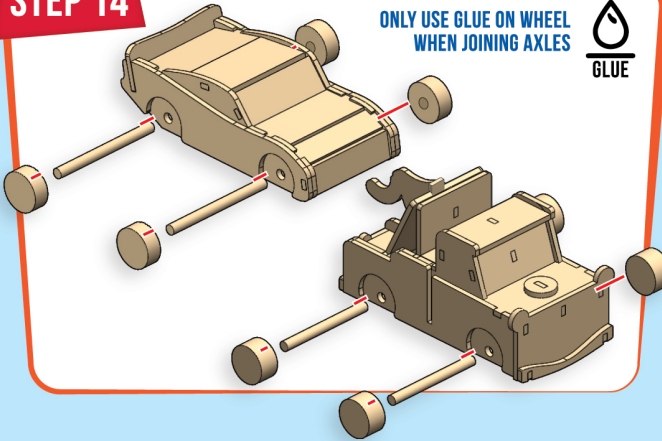

STEP 11

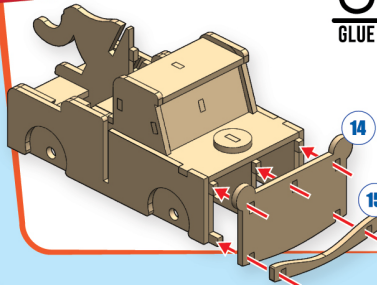

RESULT

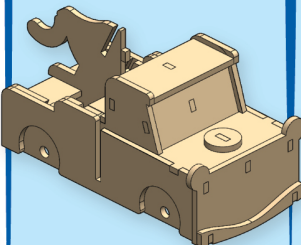

STEP 12



RESULT

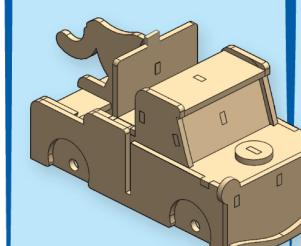

STEP 15

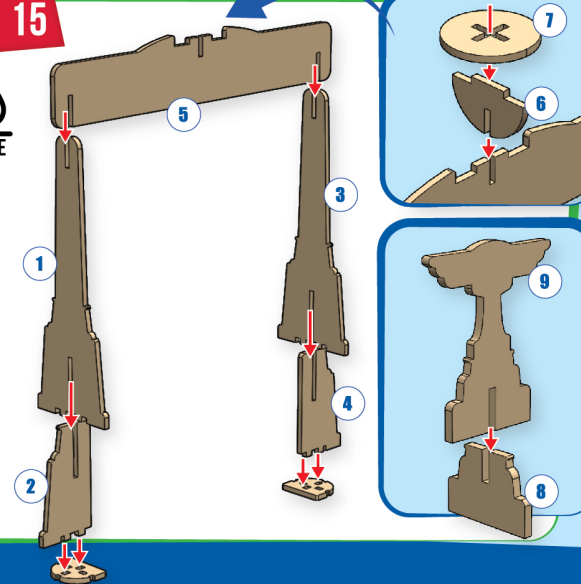

PAINT

- Lightly sand any rough areas of wood if required before painting
- Stir paint before application.
- For best results apply multiple coats of paint, allowing to dry between application.
- Clean the brush with warm water before changing colours.
- Use the picture on the front of the box as a colour guide.

STICK

Now it's time to place your stickers. Carefully peel them off the sheet but make sure the paint is dry before applying. Use the picture on the front of the box as a placement guide.



CAUTION! Adult supervision required. When using paints or glue ensure carpets, clothes and furniture are protected. Avoid contact with skin and eyes. In case of contact with eyes rinse immediately with plenty of water and seek medical advice. If swallowed seek medical advice immediately. Please remove all packaging attachments before giving to child. Adult supervision required. Please retain packaging for future reference. Colour and shape of contents may vary.



Created by © Colorific
Colorific Australia: 1 800 801 545
info@colorific.com.au
www.colorific.com.au
Designed in Australia MADE IN CHINA
Item No. 177838

WARNING:
CHOKING HAZARD - Small Parts.
Not suitable for children under 3 years.

